

Rev. no. | Revisie merk | Revisie omschrijving | Revisie datum

M. DE KROON v.o.f.
Technisch Tekeningbureau
Stalbouw

Werk: MARKTHAL PALEISKWARTIER
Onderwerp: BEGANE GROND VLOER EN -3300
Opdrachtgever: VAN DE VEN BOUW EN ONTWIKKELING BV
'S HERTOGENBOSCH

Getekend: M DE KROON
Datum: 14-02-15
Schaal: zie aanzicht

Project: 15.0034
Tekening: 001
Status: TER GOEDKEURING

Project: 15.0034
Tekening: 001
Status: TER GOEDKEURING

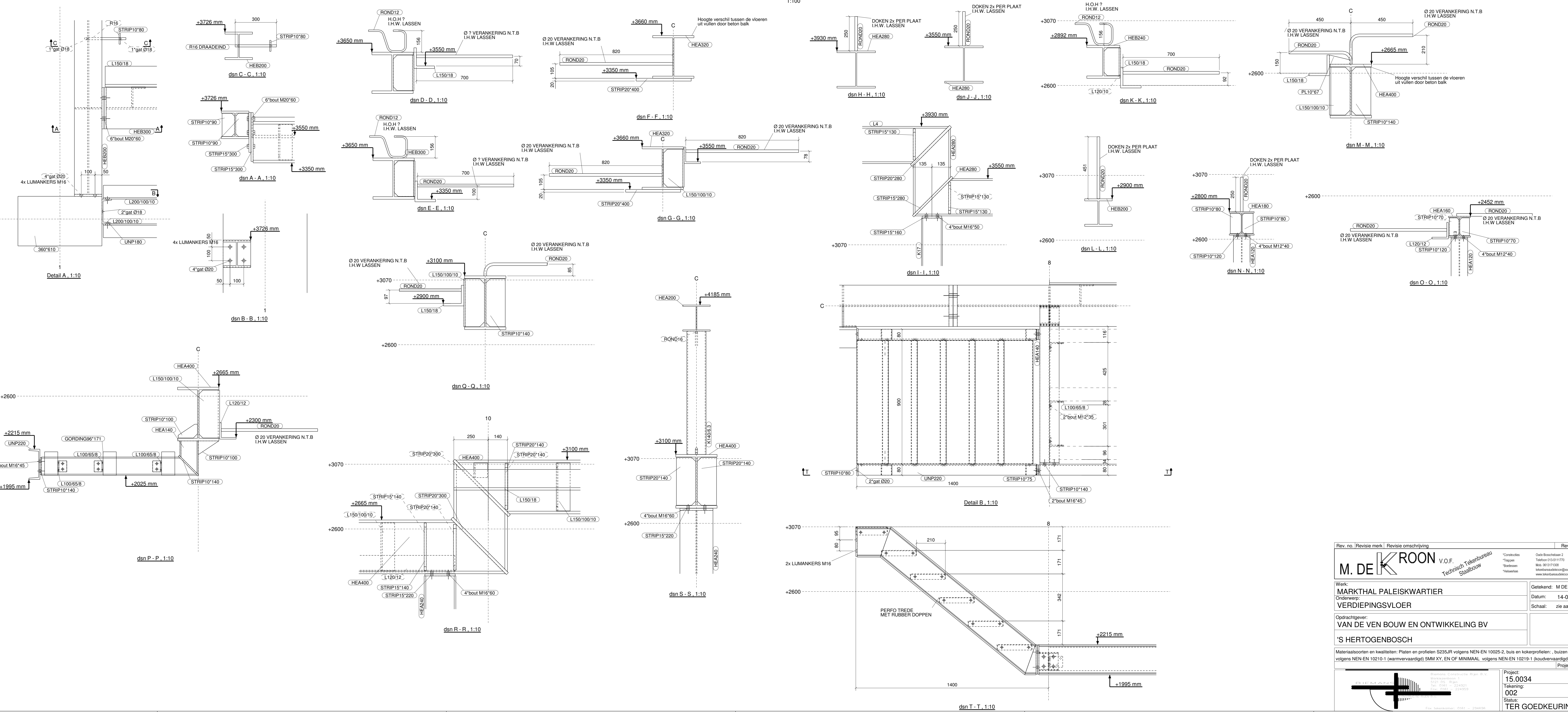

Rev. no.	Revisie merk	Revisie omschrijving	Revisie datum
M. DE KROON v.o.f. Technische Tekeningen Staalbouw			
Werk: MARKTHAL PALEISKWARTIER Onderwerp: VERDIEPINGSVLOER		Getekend: M DE KROON Datum: 14-02-15 Schaal: zie aanzicht	
Opdrachtgever: VAN DE VEN BOUW EN ONTWIKKELING BV 'S HERTOGENBOSCH			
Materiaalsoorten en kwaliteiten: Platen en profielen S235JR volgens NEN EN 10025-2, buis en kokerprofielen: buizen M volgens NEN-EN 10210-1 (warmvervaardigd) SMM XY, EN OF MINIMAAL volgens NEN-EN 10219-1 (koudvervaardigd)			
Project: 15.0034 Tekening: 002 Status: TER GOEDKEURING		Formaat: A0 Projectie:	

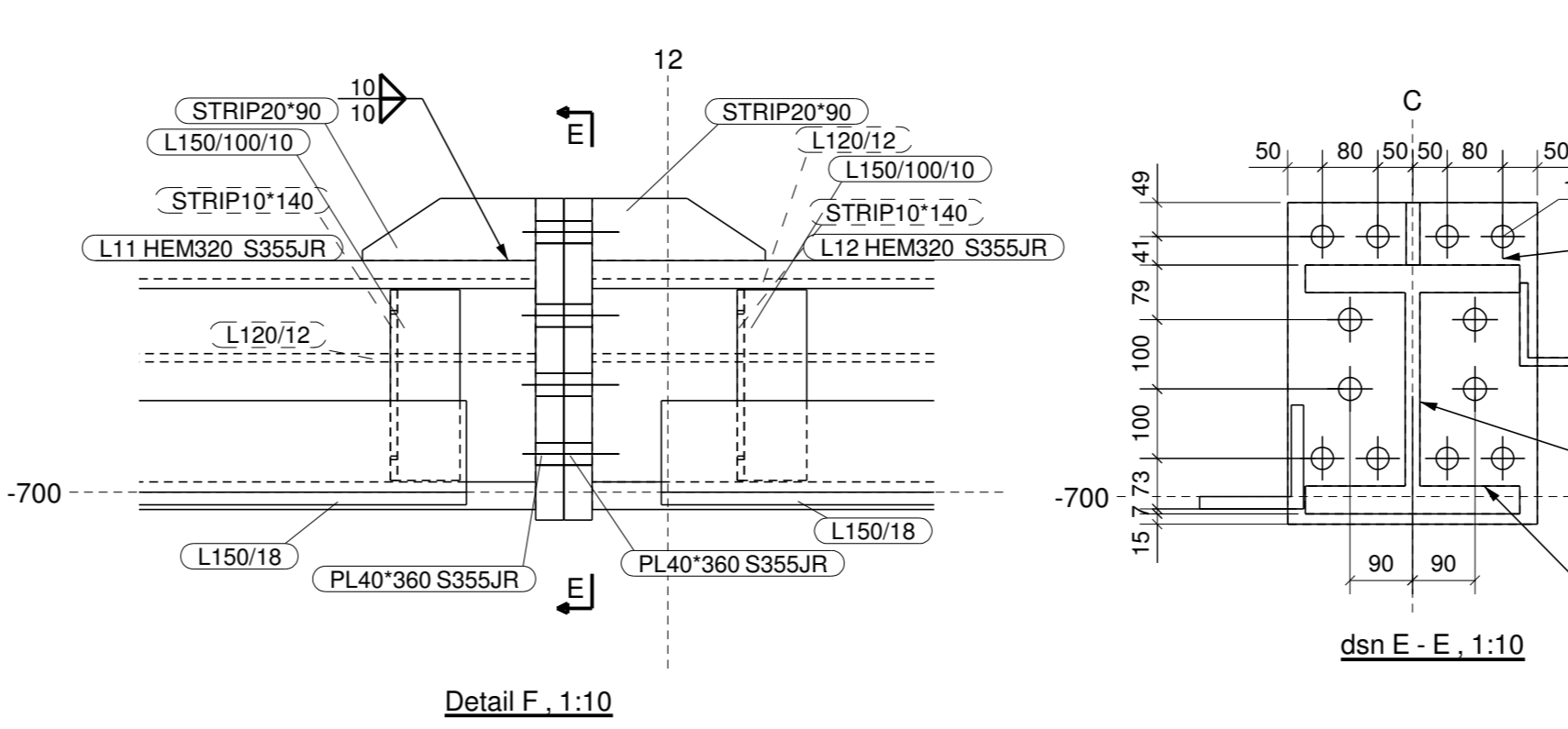
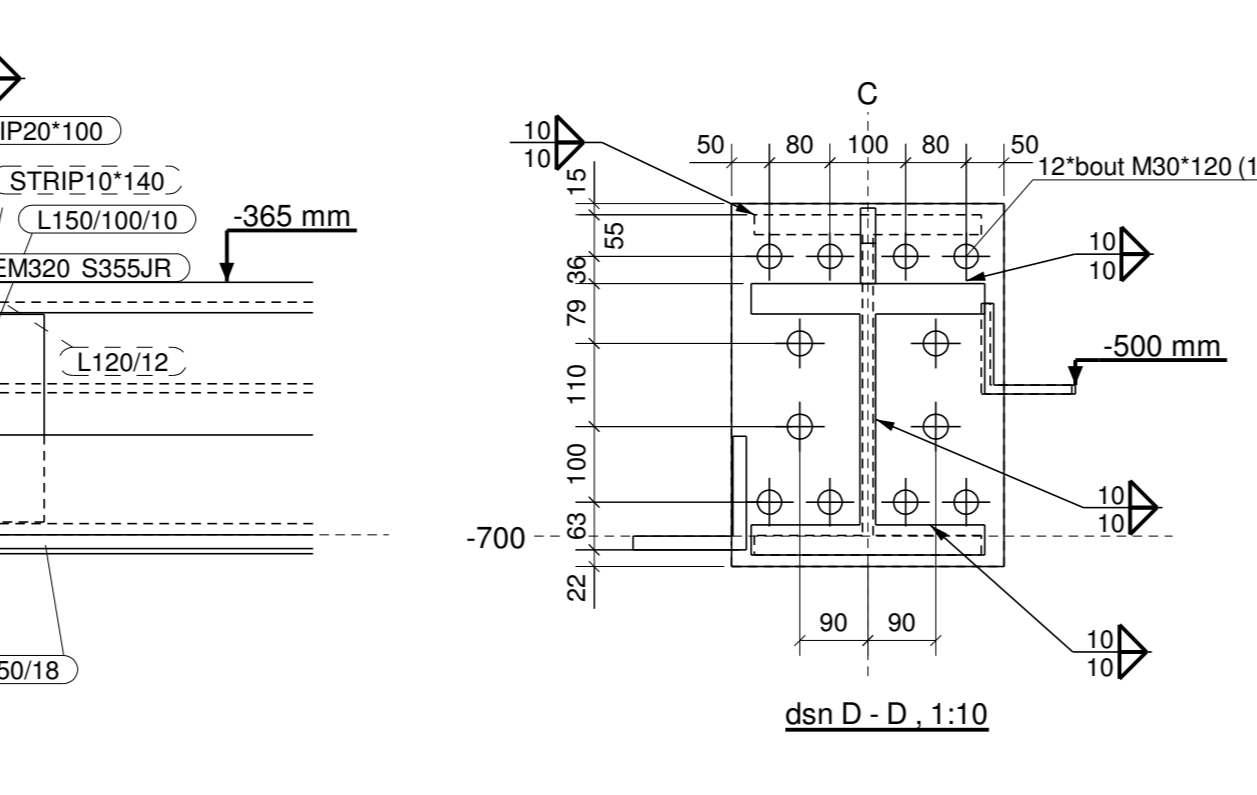
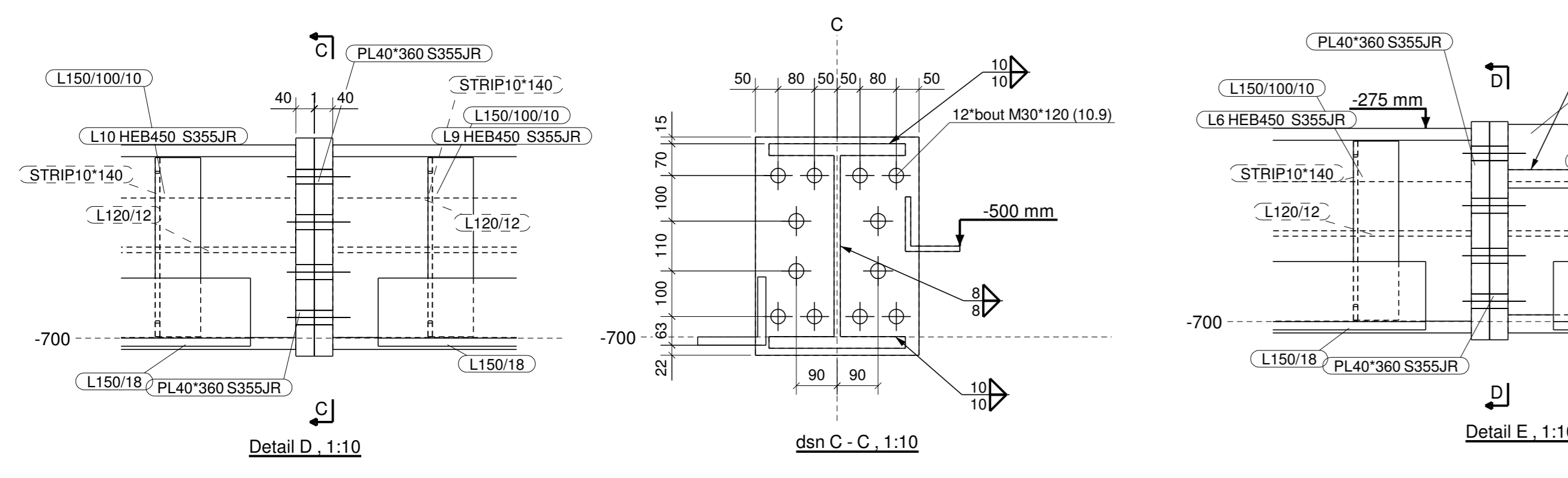
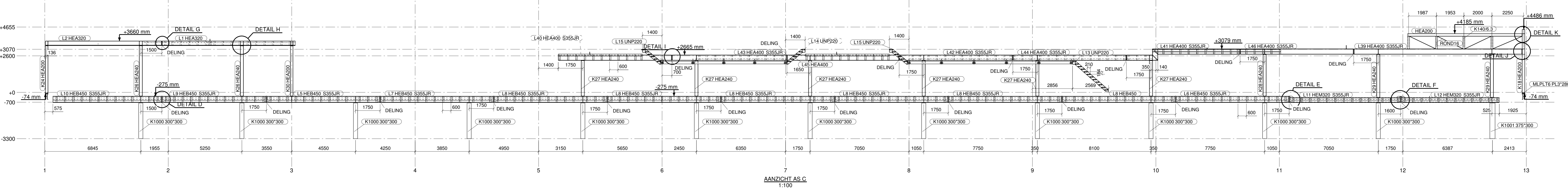
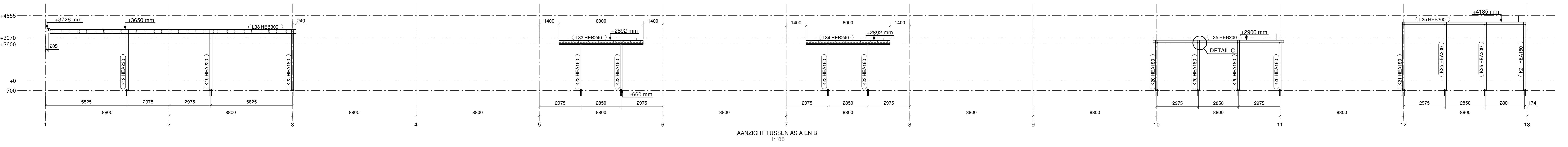
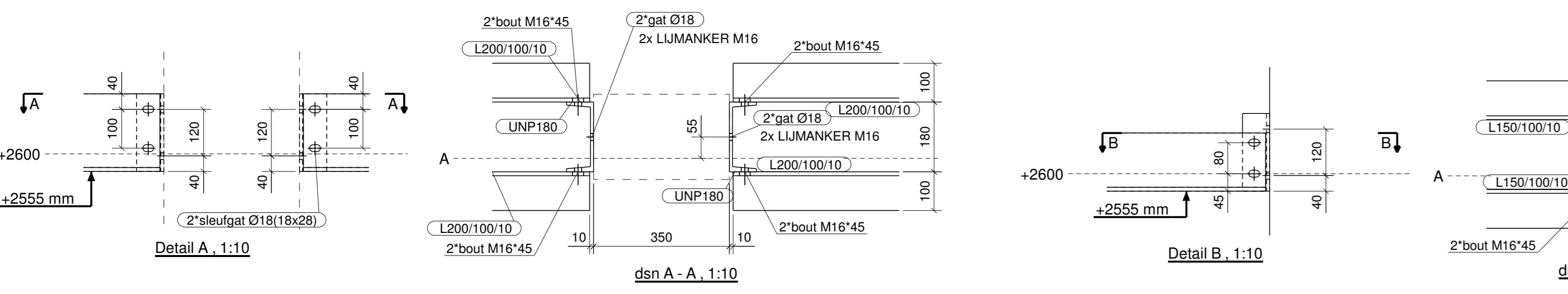
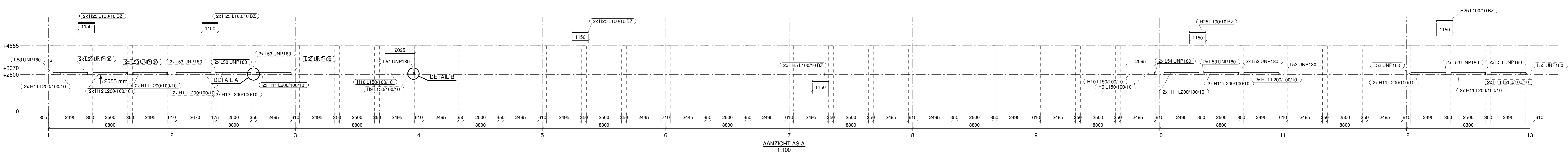

Rev. no. Revisie merk	Revisie omschrijving	Revisie datum
M. DE KROON v.o.f.		
Technisch Tekeningenbureau Staalbouw		*Construatie *Detail *Standaard *Bevestiging
Werk: MARKTHAL PALEISKWARTIER		
Onderwerp: AANZICHT AS A T/M C		
Opdrachtgever: VAN DE VEN BOUW EN ONTWIKKELING BV		
'S HERTOGENBOSCH		
Materiaalsoorten en kwaliteiten: Platen en profielen S235JR volgens NEN EN 10025-2, buis en kokerprofielen: buiten M volgens NEN-EN 10210-1 (warmvervaard) SMM XY, EN OF MINIMAAL volgens NEN-EN 10219-1 (koudevervaardigd)		
Project: 15.0034		Tekening: 003
Datum: 14-02-15		Schaal: zie aanzicht
Projectie: 		
Teknische tekening 1:100		Project: TER GOEDKEURING

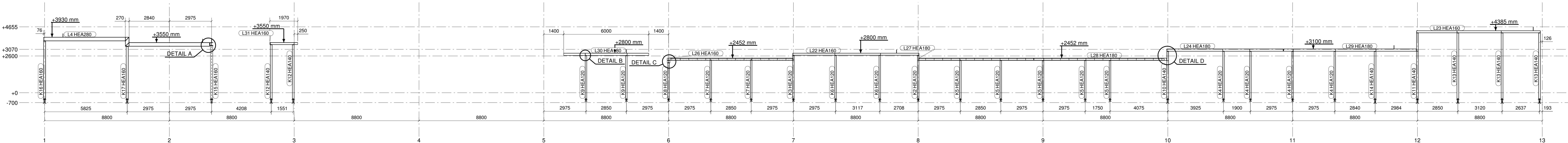

AANZICHT TUSSEN AS C EN D
1:100

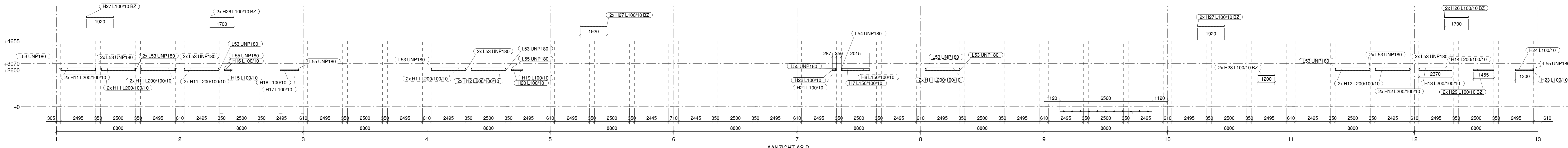
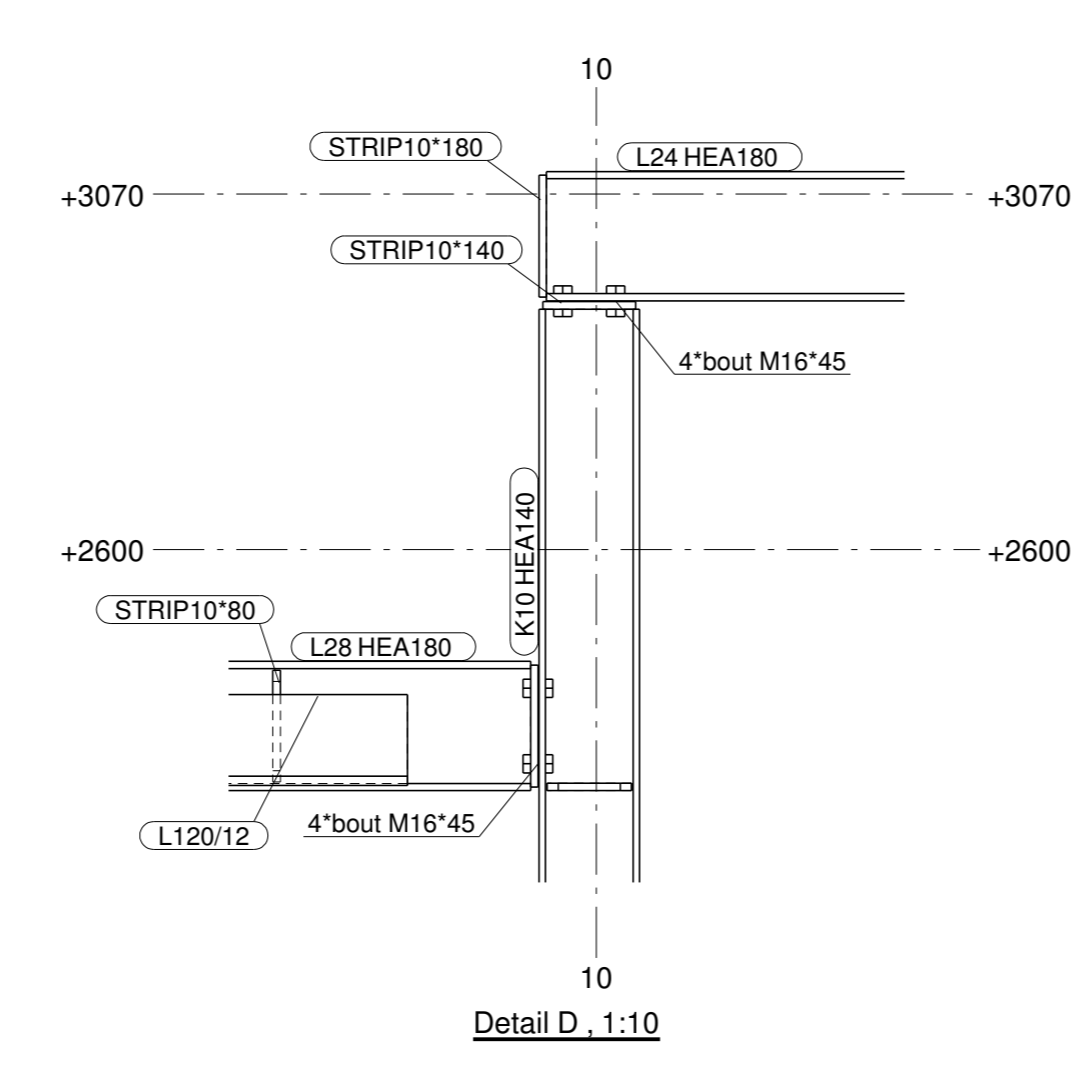
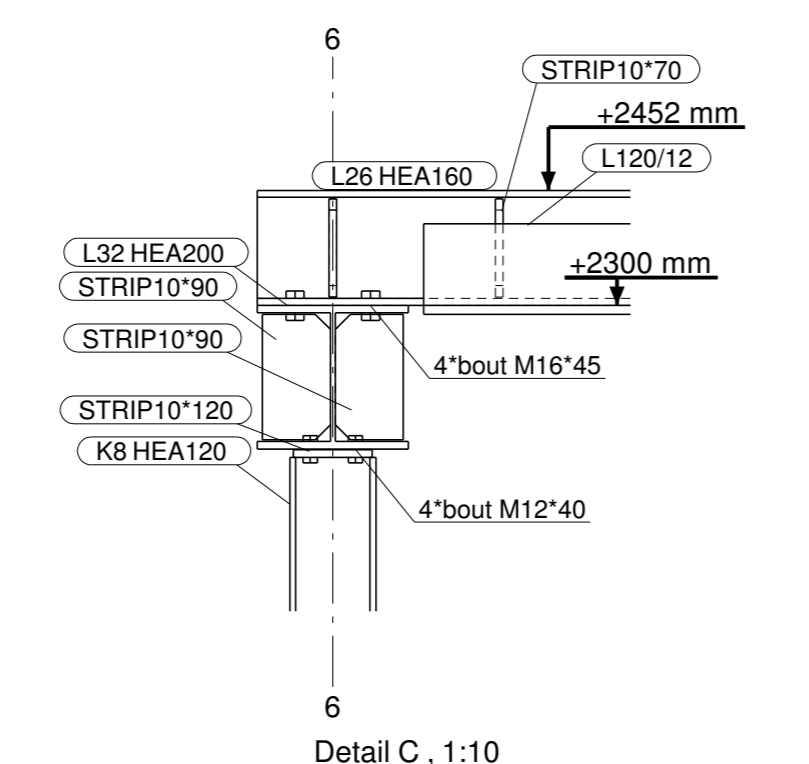
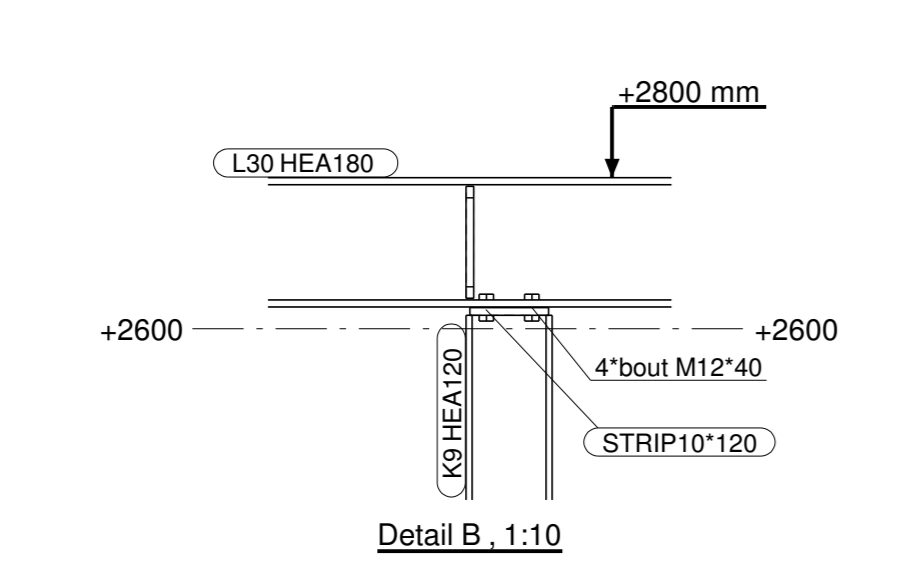
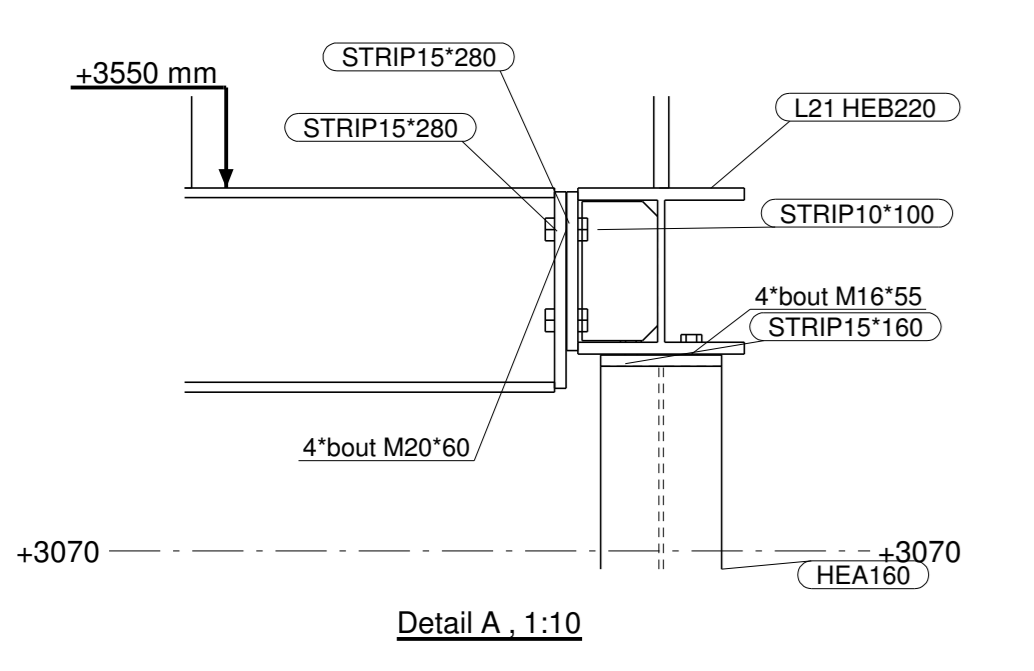

AANZICHT AS D
1:100

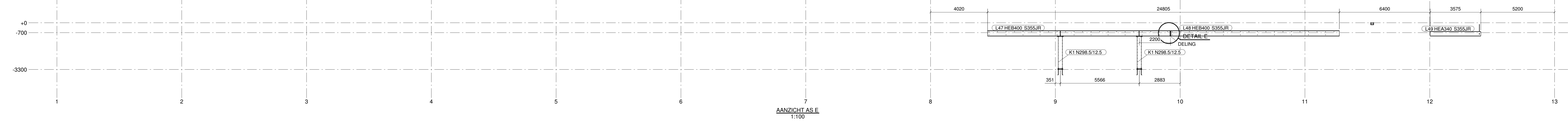

AANZICHT AS E
1:100

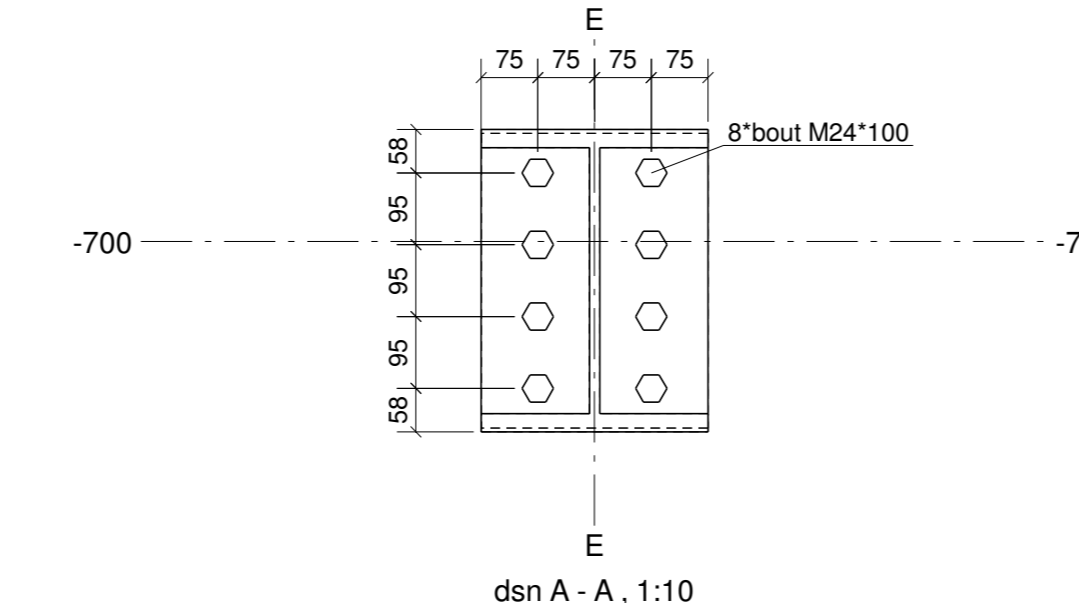
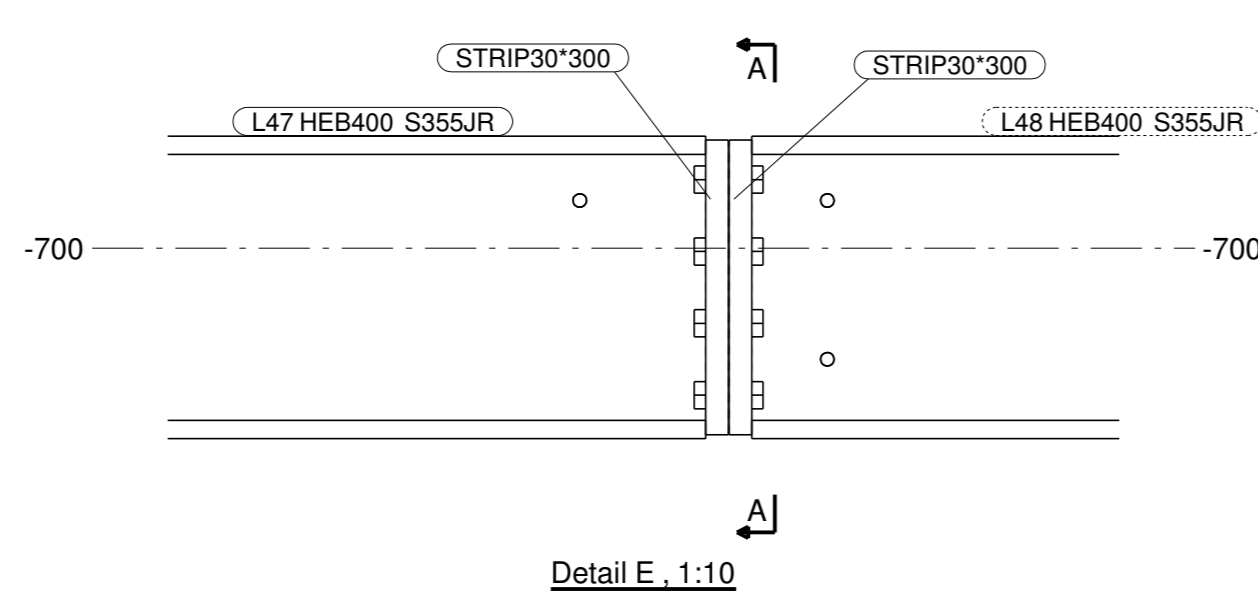

Rev. no.	Revisie merk	Revisie omschrijving	Revisie datum
Werk: MARKTHAL PALEISKWARDIER			Getekend: M. DE KROON
Onderwerp: AANZICHT AS C T/M E			Datum: 14-02-15
Opdrachtgever: VAN DE VEN BOUW EN ONTWIKKELING BV			Schaal: zie aanzicht
S'Hertogenbosch			
Materiaal-soorten en kwaliteiten: Platen en profielen S235JR volgens NEN-EN 10025-2, buis en kokerprofielen: buizen M volgens NEN-EN 10210-1 (warmvervaardigd) SMM XY, EN OF MINIMAAL volgens NEN-EN 10219-1 (koudvervaardigd)			
Project:	15.0034	Formaat:	A0
Tekening:	004	Schaal:	TER GOEDKEURING